



TÂN LẬP THÀNH plastic

Sản Phẩm Chất Lượng, Nhà Nhà Thịnh Vượng



**SẢN PHẨM
CÔNG NGHIỆP**

INDUSTRIAL PRODUCT

TANLAPTHANH.COM



TÂN LẬP THÀNH plastic

Sản Phẩm Chất Lượng, Nhà Nhà Thịnh Vượng

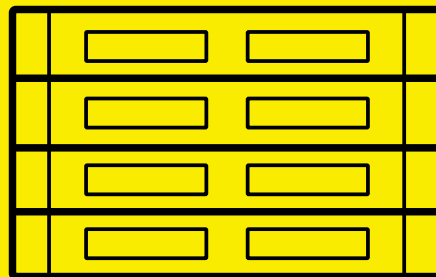
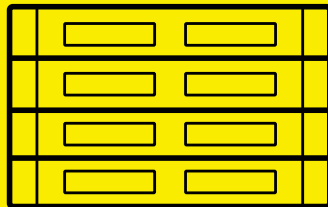

NHỰA CHẤT LƯỢNG CAO

HIGH QUALITY PLASTIC



Liên hệ

19 Triệu Quang Phục, P.10, Q.5, TP. Hồ Chí Minh

19 Triệu Quang Phục, Ward 10, District 5, Ho Chi Minh City

Tel: (+84 28) 3855 1043



www.tanlapthanh.com



info@tanlapthanh.com

GIỚI THIỆU

INTRODUCTION

Năm 1993 công ty khởi đầu bằng một xưởng quy mô gia đình sản xuất một số sản phẩm gia dụng đơn giản. Cho đến nay **Tân Lập Thành** từ khi chuyển đổi hình thức hộ gia đình sang công ty **TNHH Tân Lập Thành** đã có 2 nhà máy và 1 văn phòng đại diện.

- Với nguồn lao động chất lượng cao hơn 800 nhân viên
- Đa dạng với hơn 2000 chủng loại hàng hóa
- Với hơn 130 trang thiết bị hiện đại từ 120 tấn đến 3000 tấn
- Công suất sản xuất ấn tượng với khoảng 50.000 tấn / năm
- CNC tạo khuôn sản phẩm với độ chính xác cao
- Nguyên liệu đạt chuẩn chất lượng cao toàn quốc và quốc tế
- Khả năng sản xuất đơn hàng với số lượng lớn trong thời gian ngắn
- Sản phẩm đã có mặt trên hơn 20 quốc gia toàn cầu

In 1993, the company started with a family-sized workshop producing, some simple household products. Up to now, Tan Lap Thanh, since converting from a family - owned enterprise to a limited liability company, has had 2 factories and 1 representative office.

- With a high-quality workforce of more than 800 employees
- Diverse with more than 2,000 types of goods
- More than 130 equipment from 120 tons to 3.000 tons
- Production capacity of about 50,000 tons / year
- CNC molding products with high precision
- Materials meet national and international high-quality standards
- Ability to produce large orders in a short time
- Products are present in more than 20 countries worldwide



CHỨNG NHẬN & GIẢI THƯỞNG

CERTIFICATES & AWARDS



SMETA 4 - PILLAR



BSCI, ICTI



RCS, GRS



ISO 9001:2015



ISO 14001:2015



**HÀNG VIỆT NAM
CHẤT LƯỢNG CAO**



1
PET
Polyethylene terephthalate

- Có khả năng gây hại cho sức khỏe.
- Không nên tái sử dụng nhiều lần.
- Tránh tiếp xúc với nhiệt độ trên 50 °C.
- Không cho vào lò vi sóng.

2
HDPE
High-density polyethylene

- Chịu nhiệt tốt.
- Không gây hại tới sức khỏe.
- Cần phải vệ sinh kĩ.

3
PVC
Polyvinyl chloride

- Chứa nhiều chất độc hại ảnh hưởng tới sức khỏe.
- Không sử dụng cho thực phẩm.

4
LDPE
Low-density polyethylene

- Chịu nhiệt kém, dễ nóng chảy.
- Không dùng để đựng đồ ăn nóng, tránh nhiệt độ cao.

5
PP
Polypropylene

- Nhựa an toàn, không mùi.
- Chịu nhiệt tốt.

6
PS
Polystyrene

- Chịu nhiệt kém. Sinh ra các chất độc hại nếu tiếp xúc với nhiệt độ cao.
- Không tái sử dụng.
- Không đựng thực phẩm lâu ngày.

7
OTHER

- Một số loại có thể gây hại tới sức khỏe.
- Cần chú ý thêm các ký hiệu khác trên sản phẩm để sử dụng an toàn.

CÁC NHÃN HÀNG

BRANDS

ĐỐI TÁC

CLIENTS



Nestlé







Jollibee



A DONG PAINT

MỤC LỤC

INDEX





I.	Sản phẩm công nghiệp / Industrial product	06
	1. Pallet	06
	2. Hộp Bê Tông	10
	3. Thùng	11
	a. Thùng sơn	11
	b. Thùng đựng ốc vít	14
	c. Thùng đựng trứng cá	14
II.	Sản phẩm OEM / OEM products	15
	1. Điện tử	15
	a. Quạt đứng công nghiệp	15
	b. Quạt đứng Hàn Quốc	18
	c. Quạt treo	21
	d. Quạt xoay	23
	e. Quạt hộp	25
	f. Quạt sưởi	27
	g. Quạt 12 - 18 inches	29
	h. Quạt hút	31

**Catalogue mang tính chất tham khảo, có thể lệch so với thực tế. Quý khách vui lòng liên hệ Tân Lập Thành Plastic để đáp ứng theo nhu cầu.*

**Catalogue is for reference only and may differ from reality. Please contact Tan Lap Thanh Plastic to meet your needs.*

MỤC LỤC

INDEX

II.	Sản phẩm OEM / OEM products	15
	2. Đồ chơi	33
	3. Nông nghiệp	37
	a. Chậu trồng cây	37
	b. Thau thông minh	37
	b. Ly thủy canh	37
	4. Đóng gói	39
	5. Hũ - Nắp	41
	6. Gia dụng - hàng quà tặng, khuyến mãi	43
	a. Fami	44
	b. Jollibee	44
	c. Mikita	45
	d. Milo	45
	e. Neptune	46
	f. P/S	46
	g. Viet Nhat Paint	47
	h. Satori	47
	i. Vietnam Airlines	48

**Catalogue mang tính chất tham khảo, có thể lệch so với thực tế. Quý khách vui lòng liên hệ Tân Lập Thành Plastic để đáp ứng theo nhu cầu.*

**Catalogue is for reference only and may differ from reality. Please contact Tan Lap Thanh Plastic to meet your needs.*



Pallet nhựa

Plastic pallet

Mạnh mẽ, bền vững, chất lượng cao
Strong, durable, high quality.



Sự lựa chọn hàng đầu.

Top choices.

Với chất lượng vượt trội và độ bền cao, pallet nhựa Tân Lập Thành không chỉ giúp tối ưu hóa quy trình logistics mà còn bảo vệ môi trường với tính tái sử dụng cao.

Sản phẩm đáp ứng các tiêu chuẩn quốc tế và được sản xuất bằng công nghệ hiện đại, cam kết mang đến sự hài lòng tối đa cho khách hàng. Hãy đặt niềm tin vào pallet nhựa Tân Lập Thành để gia tăng hiệu quả kinh doanh của bạn ngay hôm nay.

With outstanding quality and high durability, Tan Lap Thanh plastic pallets not only help optimize the logistics process but also protect the environment with high reusability.

Products meet international standards and are manufactured using modern technology, committed to bringing maximum satisfaction to customers. Put your trust in Tan Lap Thanh plastic pallets to increase your business efficiency today.



TẠI SAO NÊN LỰA CHỌN SẢN PHẨM PALLET TÂN LẬP THÀNH ?

WHY SHOULD YOU CHOOSE TAN LAP THANH INDUSTRIAL PRODUCTS ?

ƯU ĐIỂM VÀ CHỨNG NHẬN

ADVANTAGES AND CERTIFICATIONS

- ▶ Kháng hóa chất, chống nước, không bị nấm mốc, mối mọt.

No fumigation, water proof, no bacteria, not absorb moisture.

- ▶ Nhiều màu sắc và kiểu dáng.

Variety of colors and designs.

- ▶ Bề mặt nhẵn, các góc bo tròn đảm bảo an toàn cho sản phẩm và người sử dụng.

Smooth surfaces, rounded corners, ensure safety for products and users.

- ▶ Hoàn toàn có thể tái chế.

Fully recyable.



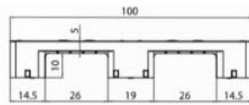
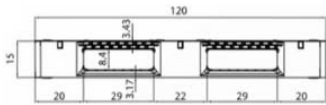
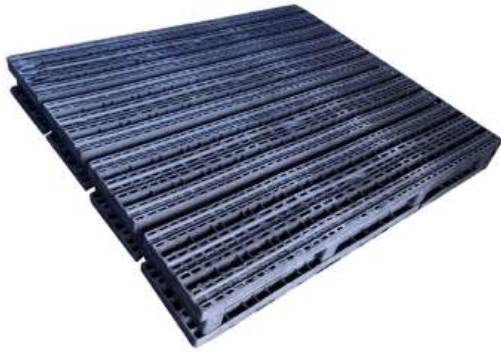

Pallet nhựa

Plastic pallet

Kích thước/ dimensions	1400×1200×15.5 (cm)
Trọng lượng/ weight	15,200 (g)
Nguyên liệu/ materials	PP
Số đường nâng/ lifting way	***
Số mặt sử dụng/ number of surfaces	1

* Lưu ý: Vui lòng liên hệ đội ngũ bán hàng, kỹ thuật công ty để được tư vấn và hướng dẫn thêm.

* Remake: Please contact the company's sales and technical team for further advice and guidance.

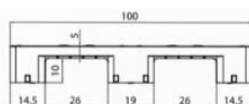
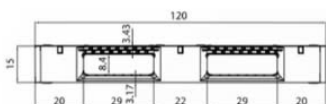

Tấm sàn Deck

Deck pannel

Kích thước/ dimensions	1400×1200×15.5 (cm)
Trọng lượng/ weight	15,200 (g)
Nguyên liệu/ materials	PP
Số đường nâng/ lifting way	***
Số mặt sử dụng/ number of surfaces	1

* Lưu ý: Vui lòng liên hệ đội ngũ bán hàng, kỹ thuật công ty để được tư vấn và hướng dẫn thêm.

* Remake: Please contact the company's sales and technical team for further advice and guidance.



Kho vận
Logistics

ỨNG DỤNG CỦA PALLET TÂN LẬP THÀNH



Lưu trữ hàng hóa
Storing & Stocking

APPLICATION OF TAN LAP THANH PALLET



Nhà xưởng
Factory



HỘP BÊ TÔNG

CONCRETE BOX



Hộp bê tông

Concrete box

Kích thước/ dimensions	475×475×160 (cm)
Trọng lượng/ weight	735 (g)
Nguyên liệu/ materials	HDPE

* Lưu ý: Vui lòng liên hệ đội ngũ bán hàng, kỹ thuật công ty để được tư vấn và hướng dẫn thêm.

* Remake: Please contact the company's sales and technical team for further advice and guidance.

Thùng sơn

Paint container

Giá thành hợp lý - Chất lượng cao
Reasonable price - High quality



Doanh nghiệp tin dùng.

Trusted by businesses.

Nhựa chất lượng cao là một yếu tố quan trọng trong sản xuất linh kiện quạt của công ty Tân Lập Thành. Đây là vật liệu được ưa chuộng vì tính linh hoạt, độ bền cao và khả năng chịu được môi trường khắc nghiệt của ứng dụng cho thùng sơn.

Thùng sơn Tân Lập Thành - Sự lựa chọn hoàn hảo! Sản phẩm được làm từ chất liệu cao cấp, đảm bảo độ bền cao, chống va đập, chịu được các điều kiện thời tiết khắc nghiệt. Thiết kế tiện lợi trong quá trình sử dụng và vận chuyển.

High quality plastic is an important factor in the production of fan components of Tan Lap Thanh. This is a preferred material because of its flexibility, high durability and ability to withstand harsh environments for paint bucket applications.

Tan Lap Thanh Paint Bucket - The perfect choice! The product is made from high-quality materials, ensuring high durability, impact resistance, and resistance to harsh weather conditions. Convenient during use and transportation.





Hình vẽ kỹ thuật / Technical sketch

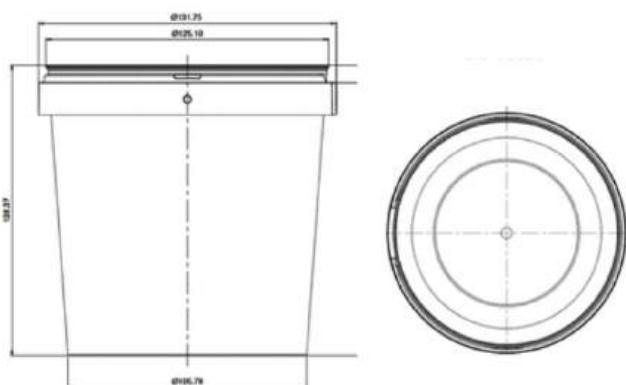

Bảng thông tin / Table of information

1	Thùng sơn 1L/ 1L container	Nhựa PP
2	Thùng sơn 3.8L/ 3.8L container	Nhựa PP
3	Thùng sơn 5L/ 3.8L container	Nhựa PP
4	Thùng sơn 15L / 15L container	Nhựa PP
5	Thùng sơn 18L/ 18L container	Nhựa PP



1. Thùng sơn 1L

Jotun paint container (1L)

Nguyên liệu/ materials	Nhựa PP
Kích thước/ dimension	12×12×12.8 (cm)
Trọng lượng/ weight	92.5 (g)



2.1. Thùng sơn nắp lỗ 3.8L

3.8L paint bucket with hole lid

Nguyên liệu/ materials	Nhựa PP
Kích thước/ dimension	20×18.7×20 (cm)
Trọng lượng/ weight	238.5 (g)



2.2. Thùng sơn nắp bằng 3.8L

Paint bucket with flat lid 3.8L

Nguyên liệu/ materials	Nhựa PP
Kích thước/ dimension	20×18.7×20 (cm)
Trọng lượng/ weight	241.5 (g)



3.1. Thùng sơn nắp lỗ 5L

5L paint bucket with hole lid

Nguyên liệu/ materials	Nhựa PP
Kích thước/ dimension	20×18.7×24.2 (cm)
Trọng lượng/ weight	292 (g)



3.2. Thùng sơn nắp bằng 5L

Paint bucket with flat lid 5L

Nguyên liệu/ materials	Nhựa PP
Kích thước/ dimension	20×18.7×24.2 (cm)
Trọng lượng/ weight	286 (g)



4.1. Thùng sơn 15L nắp bật TLT

15L paint bucket with flip lid TLT

Nguyên liệu/ materials	Nhựa PP
Kích thước/ dimension	33.2×31.8×31.6 (cm)
Trọng lượng/ weight	(g)



4.2. Thùng sơn Jotun 15L

Jotun paint bucket 15L

Nguyên liệu/ materials	Nhựa PP + FE
Kích thước/ dimension	33.2×31.8×31.6 (cm)
Trọng lượng/ weight	887 (g)



5.1. Thùng sơn nắp vặn 18L

18L screw cap paint bucket

Nguyên liệu/ materials	Nhựa PP
Kích thước/ dimension	33×32×36.2 (cm)
Trọng lượng/ weight	1069 (g)



5.2. Thùng sơn nắp lỗ 18L

18L paint bucket with hole lid

Nguyên liệu/ materials	Nhựa PP
Kích thước/ dimension	33×32×36.2 (cm)
Trọng lượng/ weight	1010.5 (g)



5.3. Thùng sơn nắp bằng 18L

Paint bucket with flat lid 18L

Nguyên liệu/ materials	Nhựa PP
Kích thước/ dimension	33×32×36.2 (cm)
Trọng lượng/ weight	1005 (g)





THÙNG ĐỰNG ỐC VÍT

SCREW CONTAINER

THÙNG ĐỰNG TRỨNG CÁ

CAVIAR CONTAINER



Thùng đựng ốc vít

Screw container

Nguyên liệu/ materials	PP, FE
Kích thước/ dimensions	34×34×32.2 cm
Trọng lượng/ weight	336 (g)

* Lưu ý: Vui lòng liên hệ đội ngũ bán hàng, kỹ thuật công ty để được tư vấn và hướng dẫn thêm.

* Remake: Please contact the company's sales and technical team for further advice and guidance.



Thùng đựng trứng cá

Caviar container

Nguyên liệu/ materials	HDPE
Kích thước/ dimensions	34×34×32.2 (cm)
Trọng lượng/ weight	1410 (g)

* Lưu ý: Vui lòng liên hệ đội ngũ bán hàng, kỹ thuật công ty để được tư vấn và hướng dẫn thêm.

* Remake: Please contact the company's sales and technical team for further advice and guidance.



Quạt xoay

Rotating fan

Giá thành hợp lý - Chất lượng cao
Reasonable price - High quality



Doanh nghiệp tin dùng.

Trusted by businesses.

Nhựa chất lượng cao là một yếu tố quan trọng trong sản xuất linh kiện quạt của công ty Tân Lập Thành. Đây là vật liệu được ưa chuộng vì tính linh hoạt, độ bền cao và khả năng chịu được môi trường khắc nghiệt của các ứng dụng quạt.

Giá thành hợp lý của linh kiện quạt của Tân Lập Thành cũng là một lợi thế lớn. Công ty này có thể cung cấp sản phẩm chất lượng cao với mức giá phù hợp với nhu cầu thị trường. Điều này là kết quả của quy trình sản xuất hiệu quả, sự tối ưu hóa chi phí và việc áp dụng công nghệ sản xuất tiên tiến.

High quality plastic is an important factor in the production of fan components of Tan Lap Thanh company. This is a popular material because of its flexibility, high durability, and ability to withstand the harsh environments of fan applications.

The reasonable price of Tan Lap Thanh's fan components is also a great advantage. This company can provide high quality products at prices suitable to market needs. This is the result of efficient production processes, cost optimization and the application of advanced manufacture technology.



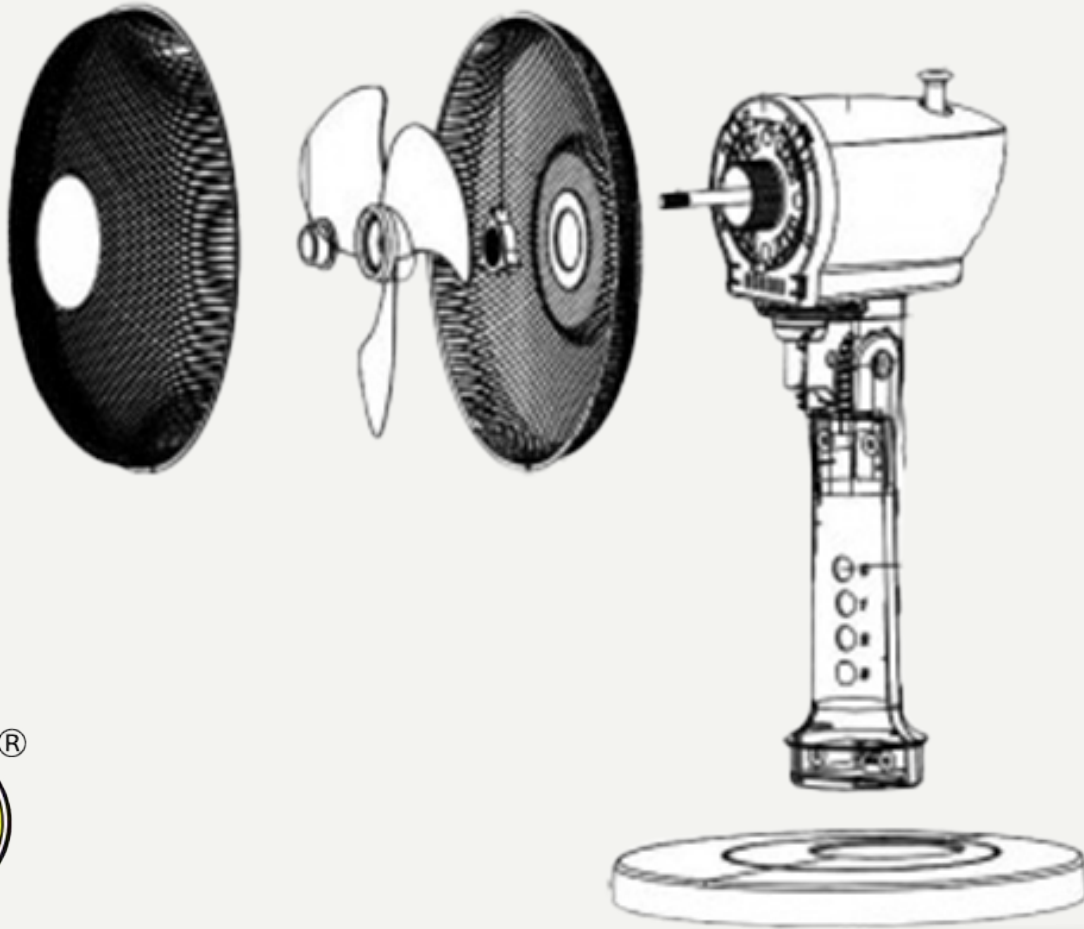

QUẠT ĐỨNG CÔNG NGHIỆP

INDUSTRIAL PEDESTAL FAN

Bảng thông tin / Table of information

1	Mặt thảo/ fan face	Nhựa PP	7	Mâm quạt/ fan tray	Nhựa PP
2	Nút contac/ contac button	Nhựa ABS	8	Ống ren ngoài/ external thread pipe	Nhựa ABS
3	Ống cổ/ neck tube	Nhựa ABS	9	Ống ren trong/ internal thread pipe	Nhựa PP
4	Cổ/ neck	Nhựa ABS	10	Hộp số/ gearbox	Nhựa ABS
5	Sơ mi cổ đứng/ stand collar	Nhựa PP	11	Trái khế/ neck shake	Nhựa ABS
6	Con trượt ống/ tube slide	Nhựa PP	12	Lắc cổ/ neck shake	Nhựa POM



1. Mặt thảo

Fan face

Nguyên liệu/ materials	Nhựa PP
Trọng lượng/ weight	17.6 (g)



2. Núc contac

Contact button

Nguyên liệu/ materials	Nhựa ABS
Trọng lượng/ weight	5 (g)



3. Ống cổ

Neck tube

Nguyên liệu/ materials	Nhựa ABS
Trọng lượng/ weight	37.2 (g)



4. Cổ

Neck

Nguyên liệu/ materials	Nhựa ABS
Trọng lượng/ weight	30.3 (g)



5. Sơ mi cổ đứng

Stand collar

Nguyên liệu/ materials	Nhựa PP
Trọng lượng/ weight	3.4 (g)



6. Con trượt ống

Tube slide

Nguyên liệu/ materials	Nhựa PP
Trọng lượng/ weight	3 (g)



7. Mâm quạt

Fan tray

Nguyên liệu/ materials	Nhựa PP
Trọng lượng/ weight	575.5 (g)



8. Ống ren ngoài

External thread pipe

Nguyên liệu/ materials	Nhựa ABS
Trọng lượng/ weight	27.4 (g)



9. Ống ren trong

Internal thread pipe

Nguyên liệu/ materials	Nhựa PP
Trọng lượng/ weight	14.5 (g)



10. Hộp số

Gear box

Nguyên liệu/ materials	Nhựa ABS
Trọng lượng/ weight	4.1 (g)



11. Trái khế

Nguyên liệu/ materials	Nhựa ABS
Trọng lượng/ weight	4.1 (g)



12. Lắc cổ

Neck shake

Nguyên liệu/ materials	Nhựa POM
Trọng lượng/ weight	1.1 (g)





QUẠT ĐỨNG HÀN QUỐC

HOUSEHOLD PENDESTAL FAN

Bảng thông tin / Table of information

1	Bầu quạt/ fan cover	Nhựa PP
2	Nạ răng/ dental mask	Nhựa PP
3	Sơ mi/ collar	Nhựa ABS
4	Cổ đứng/ standing collar	Nhựa ABS
5	Nút contac/ contac button	Nhựa ABS
6	Nắp contac/ contac hatch	Nhựa ABS
7	Ống ty/ tube	Nhựa ABS
8	Ống thân/ body tube	Nhựa ABS

9	Đế răng/ dental base	Nhựa ABS
10	Mâm quạt/ fan tray	Nhựa ABS
11	Con trượt/ slider	Nhựa POM
12	Đĩa xoay/ turntable disk	Nhựa POM
13	Mặt thảo trong/ inside view	Nhựa ABS
14	Mặt thảo ngoài/ outside view	Nhựa ABS
15	Vòng nhựa + khóa/ plastic ring + lock	Nhựa PP
16	Tán răng/ tooth spread	Nhựa ABS



1. Bầu quạt

Fan cover

Nguyên liệu/ materials	Nhựa PP
Trọng lượng/ weight	85.4 (g)



2. Nạ quạt

Dental mask

Nguyên liệu/ materials	Nhựa PP
Trọng lượng/ weight	29.3 (g)



3. Sơ mi

Collar

Nguyên liệu/ materials	Nhựa ABS
Trọng lượng/ weight	12 (g)



4. Cổ đứng

Standing collar

Nguyên liệu/ materials	Nhựa ABS
Trọng lượng/ weight	43 (g)



5. Nút contac

Contact button

Nguyên liệu/ materials	Nhựa ABS
Trọng lượng/ weight	1.4 (g)



6. Nắp contac

Contact hatch

Nguyên liệu/ materials	Nhựa ABS
Trọng lượng/ weight	34.4 (g)



7. Ống ty

Tube

Nguyên liệu/ materials	Nhựa ABS
Trọng lượng/ weight	81 (g)



8. Ống thân

Body tube

Nguyên liệu/ materials	Nhựa ABS
Trọng lượng/ weight	263 (g)



9. Đế răng

Dental base

Nguyên liệu/ materials	Nhựa ABS
Trọng lượng/ weight	101 (g)



10. Mâm quạt

Fan tray

Nguyên liệu/ materials	Nhựa ABS
Trọng lượng/ weight	370 (g)





11. Con trượt

Slider

Nguyên liệu/ materials	Nhựa POM
Trọng lượng/ weight	8.2 (g)



12. Đĩa xoay

Turnable disk

Nguyên liệu/ materials	Nhựa POM
Trọng lượng/ weight	9.15 (g)



13. Mặt thảo trong

Outside view

Nguyên liệu/ materials	Nhựa ABS
Trọng lượng/ weight	8.1 (g)

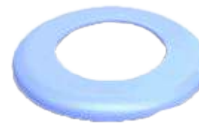

14. Mặt thảo ngoài

Outside view

Nguyên liệu/ materials	Nhựa ABS
Trọng lượng/ weight	13.76 (g)



15. Vòng nhựa + khóa

Plastic ring + lock

Nguyên liệu/ materials	Nhựa PP
Trọng lượng/ weight	44 + 0.82 (g)



16. Tán răng

Tooth spread

Nguyên liệu/ materials	Nhựa ABS
Trọng lượng/ weight	15.1 (g)





BỘ QUẠT XOAY

ROTATING FAN SET

Bảng thông tin / Table of information

1	Mặt thảo ngoài/ outside view	Nhựa ABS	8	Logo đế/ base logo	Nhựa PP
2	Đế quạt/ fan base	Nhựa PP	9	Vòng đệm contac/ contac washer	Nhựa ABS
3	Cổ quạt/ collar	Nhựa ABS	10	Chân trước+chân sau/ front leg + back leg	Nhựa ABS
4	Mặt thảo trong/ inside view	Nhựa ABS	11	Chân giữ+cần gạt contac/ holder+lever	Nhựa PP
5	Đĩa xoay mới/ new turntable	Nhựa POM	12	Contac xoay/ rotating contac	Nhựa ABS
6	Nạ quạt/ fan mask	Nhựa PP	13	Tán lồng/ cage canopy	Nhựa ABS
7	Bầu quạt/ fan cover	Nhựa PP	14	Nút kéo/ pull button	Nhựa ABS

1. Mặt thảo ngoài

Outside view



Vật liệu/ materials	Nhựa ABS
Trọng lượng/ weight	13.76 (g)



2. Đế quạt

Fan base



Vật liệu/ materials	Nhựa PP
Trọng lượng/ weight	193.6 (g)





3. Cổ quạt

Collar

Nguyên liệu/ materials	Nhựa ABS
Trọng lượng/ weight	30.3 (g)



4. Mặt tháo trong

Inside view

Nguyên liệu/ materials	Nhựa ABS
Trọng lượng/ weight	8.1 (g)



5. Đĩa xoay mới

New turnable

Nguyên liệu/ materials	Nhựa POM
Trọng lượng/ weight	9.15 (g)



6. Nạ quạt

Fan mask

Nguyên liệu/ materials	Nhựa PP
Trọng lượng/ weight	29.3 (g)



7. Bâu quạt

Fan cover

Nguyên liệu/ materials	Nhựa PP
Trọng lượng/ weight	85.4 (g)



8. Logo đế

Base logo

Nguyên liệu/ materials	Nhựa PP
Trọng lượng/ weight	3.6 (g)



9. Vòng đệm contac

Contact washer

Nguyên liệu/ materials	Nhựa ABS
Trọng lượng/ weight	16.5 (g)



10. Chân trước + chân sau

Front leg + back leg

Nguyên liệu/ materials	Nhựa ABS
Trọng lượng/ weight	116.6 (g)



11. Chân giữ + cần gạt contac

Holder + lever

Nguyên liệu/ materials	Nhựa PP
Trọng lượng/ weight	3.86 (g)



12. Contac xoay

Rotating contac

Nguyên liệu/ materials	Nhựa ABS
Trọng lượng/ weight	13.6 (g)



13. Tán lồng

Cage canopy

Nguyên liệu/ materials	Nhựa ABS
Trọng lượng/ weight	7.15 (g)



14. Nút kéo

Pull button

Nguyên liệu/ materials	Nhựa ABS
Trọng lượng/ weight	2.25 (g)





BỘ QUẠT TREO

HANGING FAN SET

Bảng thông tin / Table of information

1	Bầu quạt/ fan cover	Nhựa PP	8	Thân quạt/ fan body	Nhựa ABS
2	Nạ quạt/ fan cage	Nhựa PP	9	Đế quạt/ fan base	Nhựa PP
3	Viên thân/ body border	Nhựa ABS	10	Chấu gài vòng/ plastic ring clip	Nhựa PP
4	Cổ treo/ hanged collar	Nhựa ABS	11	Mặt thảo trong/ inside view	Nhựa PP
5	Chấu cài dây điện/ Wire clamp	Nhựa PP	12	Đĩa xoay/ rotating dish	Nhựa POM
6	Nút contac/ contac button	Nhựa ABS	13	Mặt thảo ngoài/ outside view	Nhựa ABS
7	Hài/ hai	Nhựa POM	14	Vòng nhựa + khóa/ plastic ring + lock	Nhựa PP



1. Bầu quạt

Fan cover

Nguyên liệu/ materials	Nhựa PP
Trọng lượng/ weight	85.4 (g)



2. Nạ quạt

Fan cage

Nguyên liệu/ materials	Nhựa PP
Trọng lượng/ weight	29.3 (g)





3. Viền thân

Body border

Nguyên liệu/ materials	Nhựa ABS
Trọng lượng/ weight	8.49 (g)



4. Cổ treo

Hanged collar

Nguyên liệu/ materials	Nhựa ABS
Trọng lượng/ weight	39.1 (g)



5. Chấu cài dây điện

Wire clip

Nguyên liệu/ materials	Nhựa PP
Trọng lượng/ weight	0.53 (g)



6. Nút contac

Contact button

Nguyên liệu/ materials	Nhựa ABS
Trọng lượng/ weight	4.82 (g)



7. Hài

Clip

Nguyên liệu/ materials	Nhựa POM
Trọng lượng/ weight	2.32 (g)



8. Thân quạt

Fan body

Nguyên liệu/ materials	Nhựa ABS
Trọng lượng/ weight	157.9 (g)



9. Đế quạt

Fan base

Nguyên liệu/ materials	Nhựa PP
Trọng lượng/ weight	49.39 (g)



10. Chấu gài vòng

Plastic ring clip

Nguyên liệu/ materials	Nhựa PP
Trọng lượng/ weight	0.82 (g)



11. Mặt thảo trong

Inside view

Nguyên liệu/ materials	Nhựa PP
Trọng lượng/ weight	8.1 (g)



12. Đĩa xoay

Rotating

Nguyên liệu/ materials	Nhựa POM
Trọng lượng/ weight	9.15 (g)



13. Mặt thảo ngoài

Outside view

Nguyên liệu/ materials	Nhựa ABS
Trọng lượng/ weight	9.15 (g)



14. Vòng nhựa + khóa

Plastic ring + lock

Nguyên liệu/ materials	Nhựa PP
Trọng lượng/ weight	44 (g)





BỘ QUẠT HỘP

BOX FAN SET

Bảng thông tin / Table of information

1	Lồng trước quạt hộp/ box fan front cage	Nhựa PP
2	Lồng sau quạt hộp/ box fan rear cage	Nhựa PP
3	Nắp kẹp motor quạt/ fan motor clamp cover	Nhựa PP
4	Nút lót chân quạt hộp/ box fan foot pad	Nhựa TPR

5	Chân đế quạt hộp/ box fan base	Nhựa PP
6	Nút ra dây điện/ electric wire exit button	Nhựa PP
7	Chấu cài dây điện/ wire clip	Nhựa PP



1. Lồng trước quạt hộp

Box fan front cage

Nguyên liệu/ materials	Nhựa PP
Trọng lượng/ weight	616.0 (g)

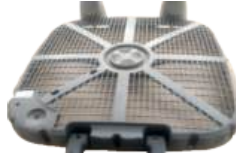

2. Lồng sau quạt hộp

Box fan rear cage

Nguyên liệu/ materials	Nhựa PP
Trọng lượng/ weight	675.0 (g)



3. Nắp kẹp motor quạt

Fan motor clamp cover

Nguyên liệu/ materials	Nhựa PP
Trọng lượng/ weight	26.5 (g)



4. Nút lót chân quạt hộp

Box fan foot pad

Nguyên liệu/ materials	Nhựa TPR
Trọng lượng/ weight	0.7 (g)

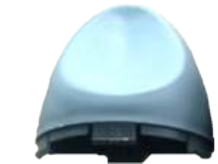

5. Chân đế quạt hộp

Box fan base

Nguyên liệu/ materials	Nhựa PP
Trọng lượng/ weight	43.5 (g)

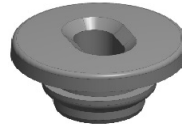

6. Nút ra dây điện

Electric wire exit button

Nguyên liệu/ materials	Nhựa PP
Trọng lượng/ weight	0.7 (g)



7. Chấu cài dây điện quạt

Fan wire clip

Nguyên liệu/ materials	Nhựa PP
Trọng lượng/ weight	0.5 (g)





BỘ QUẠT SỬỚI

FAN HEATER SET

Bảng thông tin / Table of information

1	Bầu quạt/ fan cover	Nhựa PP
2	Lồng quạt/ fan cage	Nhựa PP
3	Sơ mi/ collar	Nhựa ABS
4	Cổ đứng/ stand collar	Nhựa ABS
5	Nút timer + nút OSC/ timer button + OSC button	Nhựa ABS
6	Nắp contac/ contac hatch	Nhựa ABS
7	Ống ty/ tube	Nhựa ABS

8	Thân quạt/ fan body	Nhựa ABS
9	Đế răng/ tooth base	Nhựa ABS
10	Mâm quạt/ fan tray	Nhựa ABS
11	Con trượt/ slider	Nhựa POM
12	Đĩa xoay/ rotating	Nhựa POM
13	Trái khế contac/ contac	Nhựa POM
14	Hài chuyển hướng/ redirection	Nhựa POM



1. Bầu quạt

Fan cover

Nguyên liệu/ materials	Nhựa PP
Trọng lượng/ weight	90 (g)



2. Lồng quạt

Fan cage

Nguyên liệu/ materials	Nhựa PP
Trọng lượng/ weight	219 (g)





3. Sơ mi

Collar

Nguyên liệu/ materials	Nhựa ABS
Trọng lượng/ weight	12 (g)



4. Cổ đứng

Stand collar

Nguyên liệu/ materials	Nhựa ABS
Trọng lượng/ weight	43(g)



5. Nút timer + Nút OSC

Timer button + OSC button

Nguyên liệu/ materials	Nhựa ABS
Trọng lượng/ weight	5.2/ 5.6 (g)



6. Nắp contac

Contact hatch

Nguyên liệu/ materials	Nhựa ABS
Trọng lượng/ weight	31 (g)



7. Ống ty

Tube

Nguyên liệu/ materials	Nhựa ABS
Trọng lượng/ weight	81 (g)



8. Thân quạt

Fan body

Nguyên liệu/ materials	Nhựa ABS
Trọng lượng/ weight	263 (g)



9. Đế răng

Tooth base

Nguyên liệu/ materials	Nhựa ABS
Trọng lượng/ weight	95.3 (g)



10. Mâm quạt

Fan tray

Nguyên liệu/ materials	Nhựa ABS
Trọng lượng/ weight	330 (g)



11. Con trượt

Slider

Nguyên liệu/ materials	Nhựa POM
Trọng lượng/ weight	8.2 (g)



12. Đĩa xoay

Rotating

Nguyên liệu/ materials	Nhựa POM
Trọng lượng/ weight	8.9 (g)



13. Trái khế contac

Contact

Nguyên liệu/ materials	Nhựa POM
Trọng lượng/ weight	3.0 (g)



14. Hài chuyển hướng

Redirection

Nguyên liệu/ materials	Nhựa POM
Trọng lượng/ weight	2.4 (g)





QUẠT 12 - 18 INCHES

12 - 18 INCHES FAN

Bảng thông tin / Table of information

1	Hộp CT quạt 12,18 inch/ CT Fan Box 12.18 inch	Nhựa ABS	4	Nút cao su lồng quạt 12/ fan cage rubber stopper	Nhựa TPR
2	Nút ra dây nguồn OVAL/ OVAL power cord outlet	Nhựa TPR	5	Nút cao su lồng quạt 18/ fan cage rubber stopper	Nhựa TPR
3	Kẹp dây nguồn/ power cord clamp	Nhựa ABS	6	Ống canh 10ly (phi 12)/ 10mm tube (diameter 12)	Nhựa POM

1. Hộp CT quạt 12, 18 inch

CT fan box 12, 18 inch



Nguyên liệu/ materials	Nhựa ABS
Trọng lượng/ weight	40 (g)



2. Nút ra dây nguồn OVAL

OVAL power cord outlet

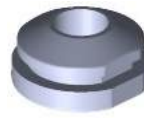

Nguyên liệu/ materials	Nhựa TPR
Trọng lượng/ weight	2 (g)



3. Kẹp dây nguồn

Power cord clamp



Nguyên liệu/ materials	Nhựa ABS
Trọng lượng/ weight	1.1 (g)



4. Nút cao su lồng quạt 12

Fan cage rubber stopper



Nguyên liệu/ materials	Nhựa TPR
Trọng lượng/ weight	3.5 (g)



5. Nút cao su lồng quạt 18

Fan cage rubber stopper



Nguyên liệu/ materials	Nhựa TPR
Trọng lượng/ weight	6.9 (g)



6. Ống canh 10ly (phi 12)

10 mm tube (diameter 12)

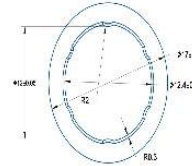

Nguyên liệu/ materials	Nhựa POM
Trọng lượng/ weight	1.6 (g)





QUẠT HÚT

SUCTION FAN

Bảng thông tin / Table of information

1 Thân quạt/ body	Nhựa PP
2 Vỏ bọc trước/ cover	Nhựa PP
3 Móc trượt/ slide hook	Nhựa PP
4 Bình đựng dầu/ oil pot	Nhựa PP
5 Nắp chụp/ spinner	Nhựa PP

6 Cánh quạt/ fan	Nhựa PP
7 Cửa chớp/ shutter	Nhựa PP
8 Liên kết/ link	Nhựa ABS
9 Hộp công tắc/ switch board	Nhựa PP



1. Thân quạt

Body

Nguyên liệu/ materials	Nhựa PP
Trọng lượng/ weight	378.85 (g)



2. Vỏ bọc trước

Cover

Nguyên liệu/ materials	Nhựa PP
Trọng lượng/ weight	362.02 (g)



3. Móc trượt

Slide hook

Nguyên liệu/ materials	Nhựa PP
Trọng lượng/ weight	0.75 (g)



4. Bình đựng dầu

Oil pot

Nguyên liệu/ materials	Nhựa PP
Trọng lượng/ weight	13.69 (g)



5. Nắp chụp

Spinner

Nguyên liệu/ materials	Nhựa PP
Trọng lượng/ weight	22.91 (g)



6. Cánh quạt

Fan

Nguyên liệu/ materials	Nhựa PP
Trọng lượng/ weight	101.04 (g)



7. Cửa chớp

Shutter

Nguyên liệu/ materials	Nhựa PP
Trọng lượng/ weight	63.99 (g)



8. Liên kết

Link

Nguyên liệu/ materials	Nhựa ABS
Trọng lượng/ weight	19.32 (g)



9. Hộp công tắc

Switch board

Nguyên liệu/ materials	Nhựa PP
Trọng lượng/ weight	8.96 (g)



Đồ chơi

Toys

Giá thành hợp lý - Chất lượng cao
Reasonable price - High quality



Sản phẩm được sử dụng toàn cầu.

Products are used globally.

Tân Lập Thành tự hào là đối tác gia công sản xuất đồ chơi cho Vikings, cung cấp chất liệu nhựa chất lượng cao với tiêu chuẩn an toàn quốc tế. Tất cả sản phẩm đều được kiểm định nghiêm ngặt, đảm bảo không chứa chất độc hại và phù hợp với nhu cầu của trẻ em.

Với cam kết mang đến những sản phẩm an toàn và bền bỉ, Tân Lập Thành và Vikings hướng tới việc tạo ra niềm vui và sự phát triển cho thế hệ tương lai trên toàn cầu.

Tan Lap Thanh is proud to be a toy manufacturing partner for Vikings, providing high quality plastic materials with international safety standards. All products are strictly tested, ensuring they do not contain toxic substances and are suitable for children's needs.

With a commitment to providing safe and durable products, Tan Lap Thanh and Vikings aim to create joy and development for future generations globally.

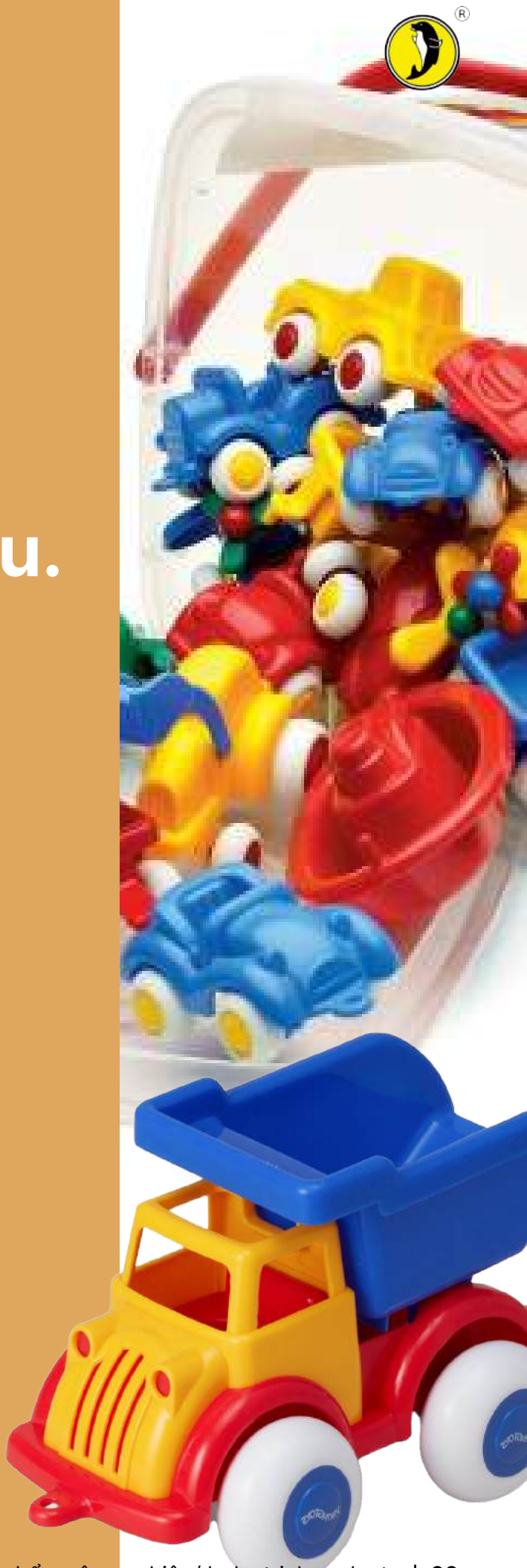



CÁC LOẠI ĐỒ CHƠI VIKINGS

VIKINGS TOYS

Xe S. Golf

S. Golf car



Nguyên liệu/ materials	Nhựa PP
Trọng lượng/ weight	22.3 (g)



Xe S. Porsche

S. Porsche car



Nguyên liệu/ materials	Nhựa PP
Trọng lượng/ weight	17.6 (g)



Xe S. Volvo

S. Volvo car



Nguyên liệu/ materials	Nhựa PP
Trọng lượng/ weight	22.3 (g)



Xe S. Beetle

S. Beetle car



Nguyên liệu/ materials	Nhựa PP
Trọng lượng/ weight	18.7 (g)



Rơ móc Mini Trailer

Mini trailer



Nguyên liệu/ materials	Nhựa PP
Trọng lượng/ weight	21.3 (g)



Xe Mini Roaster

Mini roaster car



Nguyên liệu/ materials	Nhựa PP
Trọng lượng/ weight	24.5 (g)



Xe Mini Jeep

Mini Jeep



Nguyên liệu/ materials	Nhựa PP
Trọng lượng/ weight	26.5 (g)



Xe Mini Pick Up

Mini Pick Up truck



Nguyên liệu/ materials	Nhựa PP
Trọng lượng/ weight	29.1 (g)





Máy cày Mini Tractor

Mini tractor

Nguyên liệu/ materials	Nhựa PP
Trọng lượng/ weight	30.7 (g)



Thuyền nhỏ

Small boat

Nguyên liệu/ materials	Nhựa PP
Trọng lượng/ weight	18 (g)



Xe Chubby Coupe

Chubby coupe

Nguyên liệu/ materials	Nhựa PP
Trọng lượng/ weight	52 (g)



Xe Chubby Roadster

Chubby roadster

Nguyên liệu/ materials	Nhựa PP
Trọng lượng/ weight	53.5 (g)



Xe Chubby Pick up

Chubby pick up

Nguyên liệu/ materials	Nhựa PP
Trọng lượng/ weight	56 (g)



Xe ủi Chubby Bulldozer

Chubby bulldozer

Nguyên liệu/ materials	Nhựa PP
Trọng lượng/ weight	51 (g)



Rơ móc Chubby Trailer

Chubby trailer

Nguyên liệu/ materials	Nhựa PP
Trọng lượng/ weight	47 (g)



Máy bay Chubby Plane

Chubby plane

Nguyên liệu/ materials	Nhựa PP
Trọng lượng/ weight	37.12 (g)



Trực thăng Chubby Helicop

Cb helicop

Nguyên liệu/ materials	Nhựa PP
Trọng lượng/ weight	29.62 (g)



Đầu máy xe lửa Chubby Loco

Cb loco

Nguyên liệu/ materials	Nhựa PP
Trọng lượng/ weight	58.3 (g)



Toa Chubby Pass Wagon

Cb pass wagon

Nguyên liệu/ materials	Nhựa PP
Trọng lượng/ weight	55 (g)



Xe Mini Sport

Mini sport

Nguyên liệu/ materials	Nhựa PP
Trọng lượng/ weight	22.6 (g)





Xe Mini Suv

Mini SUV

Nguyên liệu/ materials	Nhựa PP
Trọng lượng/ weight	31.8 (g)



Máy bay Mini Plane

Mini plane

Nguyên liệu/ materials	Nhựa PP
Trọng lượng/ weight	19.42 (g)



Trục thẳng Mini Helicopter

Mini helicopter

Nguyên liệu/ materials	Nhựa PP
Trọng lượng/ weight	14.62 (g)



Máy bay Mini Jet

Mini jet

Nguyên liệu/ materials	Nhựa PP
Trọng lượng/ weight	16.8 (g)



Xe Mini Van

Mini van

Nguyên liệu/ materials	Nhựa PP
Trọng lượng/ weight	28.7 (g)



Xe hơi Mini Couple

Mini couple

Nguyên liệu/ materials	Nhựa PP
Trọng lượng/ weight	25.6 (g)



Xe ben Mini Tipper

Mini tipper

Nguyên liệu/ materials	Nhựa PP
Trọng lượng/ weight	36.3 (g)



Xe cứu hoả Mini Fire

Mini fire

Nguyên liệu/ materials	Nhựa PP
Trọng lượng/ weight	29.6 (g)



Xe cứu thương Mini Ambulance

Mini ambulance

Nguyên liệu/ materials	Nhựa PP
Trọng lượng/ weight	36.6 (g)



Nông nghiệp

Agriculture

Giá thành hợp lý - Chất lượng cao
Reasonable price - High quality



Doanh nghiệp tin dùng.

Trusted by businesses.

Nhựa chất lượng cao là một yếu tố quan trọng trong sản xuất linh kiện quạt của công ty Tân Lập Thành. Đây là vật liệu được ưa chuộng vì tính linh hoạt, độ bền cao và khả năng chịu được môi trường khắc nghiệt các ứng dụng nông nghiệp.

Sản phẩm nông nghiệp Tân Lập Thành - Sự lựa chọn hoàn hảo cho sức khỏe gia đình! Được sản xuất theo quy trình nghiêm ngặt, không sử dụng hóa chất độc hại, sản phẩm của chúng tôi đảm bảo an toàn tuyệt đối cho sức khỏe. Mỗi sản phẩm chậu, ly đều mang đến chất lượng cao và vô cùng tuyệt vời.

High quality plastic is an important factor in the production of fan components of Tan Lap Thanh. This is a preferred material because of its flexibility, high durability and ability to withstand harsh environments in agricultural applications.

Tan Lap Thanh agricultural products - The perfect choice for family health! Produced according to strict processes, without using toxic chemicals, our products ensure absolute safety for health. Each pot and cup product brings high quality and is extremely wonderful.





CHẬU - THAU - LY

POT - CUP



Chậu trồng cây

Plant pot

Nguyên liệu/ materials	Nhựa PP
Trọng lượng/ weight	460 (g)



Thau thông minh

Smart pot

Nguyên liệu/ materials	Nhựa PP
Trọng lượng/ weight	460 (g)



Ly thủy canh

Hydroponic cups

Nguyên liệu/ materials	Nhựa PP
Trọng lượng/ weight	22 (g)





Đóng gói

Packaging

Giá thành hợp lý - Chất lượng cao
Reasonable price - High quality



Doanh nghiệp tin dùng.

Trusted by businesses.

Đóng gói không chỉ là bao bì, mà còn là bộ mặt của sản phẩm. Thiết kế tinh tế, màu sắc hài hòa, thông tin sản phẩm rõ ràng, bao bì của chúng tôi giúp sản phẩm của bạn trở nên hấp dẫn hơn trong mắt người tiêu dùng, nâng cao giá trị thương hiệu.

Sản phẩm đóng gói của chúng tôi là lá chắn bảo vệ hoàn hảo cho sản phẩm của bạn! Với chất liệu cao cấp, công nghệ sản xuất hiện đại, bao bì của chúng tôi đảm bảo sản phẩm luôn được bảo vệ tối ưu trong suốt quá trình vận chuyển và bảo quản, tránh các tác động từ môi trường như va đập, ẩm ướt, bụi bẩn.

Packaging is not just the packaging, but also the face of the product. Sophisticated design, variety colors, clear product information, our packaging helps your product become more attractive in the eyes of consumers, enhancing brand value.

The reasonable price of Tan Lap Thanh's fan components is also a great advantage. This company can provide high quality products at prices suitable to market needs. This is the result of efficient production processes, cost optimization and the application of advanced manufacture technology.



CÁC LOẠI DÂY - QUAI

TYPES OF WIRES- STRAPS

Đế thùng mì

Noodle box base



Nguyên liệu/ materials	Nhựa PP
Trọng lượng/ weight	1.8 (g)



Quai thùng mì

Noodle box handle



Nguyên liệu/ materials	Nhựa PP
Trọng lượng/ weight	1.8 (g)



Dây nấc

Hiccup wire



Nguyên liệu/ materials	Nhựa PP
Trọng lượng/ weight	(g)



Hũ nắp

Jar lid

Giá thành hợp lý - Chất lượng cao
Reasonable price - High quality



Doanh nghiệp tin dùng.

Trusted by businesses.

Với kinh nghiệm nhiều năm trong lĩnh vực sản xuất hũ nắp, chúng tôi luôn không ngừng cải tiến và sáng tạo để mang đến những sản phẩm chất lượng tốt nhất cho khách hàng.

Hũ nắp Tân Lập Thành - Giải pháp đóng gói hoàn hảo cho mọi sản phẩm. Từ thực phẩm, mỹ phẩm, hóa chất đến các sản phẩm thủ công, hũ nắp của chúng tôi đáp ứng mọi nhu cầu đóng gói của bạn. Thiết kế tiện lợi, dễ dàng sử dụng và bảo quản. Thiết kế đa dạng, màu sắc phong phú, hũ nắp hoàn toàn đáp ứng được nhu cầu mọi người.

With many years of experience in the field of jar and lid manufacturing, we are constantly improving and innovating to bring the best quality products to customers.

Tan Lap Thanh lid jars - The perfect packaging solution for all products. From food, cosmetics, chemicals to handmade products, our lid jars meet all your packaging needs. Convenient design, easy to use and preserve. Diverse design, rich colors, lid jars completely meet everyone's needs.





Nắp lon sữa

Milk can lid

Nguyên liệu/ materials	Nhựa LDPE
Trọng lượng/ weight	8.7 - 9.8 (g)



Nắp hộp kem 450ml

Ice cream box lid

Nguyên liệu/ materials	Nhựa PP
Trọng lượng/ weight	10 (g)



Nắp thoát khí

Air vent

Nguyên liệu/ materials	Nhựa PP
Trọng lượng/ weight	1.8 (g)



Nắp ly cháo

Porridge cup lid

Nguyên liệu/ materials	Nhựa PP
Trọng lượng/ weight	(g)



Nắp đậy lò vi sóng

Microwave oven cover

Nguyên liệu/ materials	Nhựa PP
Trọng lượng/ weight	(g)



Nắp can 60L

60L can lid

Nguyên liệu/ materials	Nhựa PP
Trọng lượng/ weight	(g)



Nắp kem

Ice cream lid

Nguyên liệu/ materials	Nhựa PP
Trọng lượng/ weight	10.5 (g)



Nắp cờ

Flag cap

Nguyên liệu/ materials	Nhựa PP
Trọng lượng/ weight	3 (g)



Nắp can

Can lid

Nguyên liệu/ materials	Nhựa PP
Trọng lượng/ weight	19 (g)



Nắp lót PAULIN

PAULIN liner lid

Nguyên liệu/ materials	Nhựa PP
Trọng lượng/ weight	4 / 9 (g)





Hàng quà tặng khuyến mãi

Promotional gift items

Giá thành hợp lý - Chất lượng cao
Reasonable price - High quality



Doanh nghiệp tin dùng.

Trusted by businesses.

Quà tặng khuyến mãi từ Tân Lập Thành - Cách tuyệt vời để khẳng định thương hiệu! Với thiết kế độc đáo, in logo sắc nét, quà tặng của chúng tôi không chỉ là món quà ý nghĩa mà còn là công cụ quảng bá thương hiệu hiệu quả.

Sản phẩm của chúng tôi được làm từ chất liệu cao cấp, đảm bảo độ bền và tính thẩm mỹ. Mỗi món quà đều mang một thông điệp riêng, giúp bạn tạo ấn tượng sâu sắc với khách hàng.

Promotional gifts from Tan Lap Thanh - A great way to affirm your brand! With unique designs and sharp logo printing, our gifts are not only meaningful gifts but also effective brand promotion tools.

Our products are made from high-quality materials, ensuring durability and aesthetics. Each gift carries a unique message, helping you create a deep impression on customers.





1. Bình nhựa quà tặng Fami, sản phẩm từ nhựa Tân Lập Thành, bền bỉ và thân thiện với môi trường.

2. Chọn bình nhựa Fami làm quà tặng, bạn không chỉ tặng sản phẩm mà còn gửi gắm sự chăm sóc và tinh tế.

1. Fami gift plastic bottle, product from Tan Lap Thanh plastic, durable and environmentally friendly.

2. Choosing Fami plastic bottles as gifts, you are not only giving a product but also sending your care and sophistication.



Jollibee

1. Ly nhựa quà tặng Jollibee làm từ nhựa Tân Lập Thành, đảm bảo độ bền và an toàn cho sức khỏe.

2. Với thiết kế ngộ nghĩnh và sắc màu nổi bật, ly nhựa Jollibee là món quà lý tưởng cho trẻ em và gia đình.

1. Jollibee gift plastic cups are made from Tan Lap Thanh plastic, ensuring durability and safety for health.

2. With its fun design and striking colors, Jollibee plastic cups are the ideal gift for children and families.





1. Để nhựa kẹo Mikita mang đến tiện lợi và phong cách cho khách hàng Unifarm Việt Nam.

2. Sản phẩm bền bỉ và an toàn, để nhựa kẹo Mikita là lựa chọn hoàn hảo cho buổi tiệc và sự kiện đặc biệt.

1. Mikita candy plastic base brings convenience and style to Unifarm Vietnam customers.

2. Durable and safe, Mikita candy plastic base is the perfect choice for parties and special events.



Cốc nhựa và bình nhựa có nắp từ Tân Lập Thành đồng hành cùng Milo, mang đến sự tiện lợi và phong cách cho mọi hoạt động thể thao. Thiết kế năng động, bền bỉ giúp bạn luôn sẵn sàng cho những phút giây thể thao sôi động hằng ngày.

Tan Lap Thanh plastic cups and plastic bottles with lids accompany Milo, bringing convenience and style to all sports activities. Dynamic, durable design helps you always be ready for exciting sports moments every day.





1. Thìa nhựa quà tặng Neptune. sản phẩm mang đến sự tiện lợi và an toàn cho mọi bữa ăn và người sử dụng.

2. Với thiết kế tinh tế và màu sắc bắt mắt, thìa nhựa Neptune là lựa chọn hoàn hảo cho bữa tiệc và sự kiện

1. Neptune gift plastic spoon. The product brings convenience and safety to every meal and user.

2. With its sophisticated design and eye-catching colors, Neptune plastic spoons are the perfect choice for parties and events.



1. Đế cắm bàn chải P/S. sản phẩm từ nhựa Tân Lập Thành, mang đến sự tiện ích cho không gian vệ sinh cá nhân.

2. Chọn đế cắm bàn chải P/S làm quà tặng, bạn gửi gắm sự chăm sóc và phong cách đến từng gia đình.

1. P/S toothbrush holder. product from Tan Lap Thanh plastic, brings convenience to personal hygiene space.

2. Choose P/S toothbrush holder as a gift, you send care and style to each family.



SATORI

1. Ca nhiệt Satori giữ nhiệt hoàn hảo cho đồ uống, giúp bạn tận hưởng hương vị lâu hơn.

2. Với thiết kế tinh tế và màu sắc bắt mắt, bình nhựa Satori thể hiện sự sang trọng và chất lượng.

1. Satori thermos keeps drinks perfectly warm, allowing you to enjoy the flavor longer.

2. With sophisticated design and eye-catching colors, Satori plastic bottles represent luxury and quality.



VIET NHAT PAINT

1. Ca cách nhiệt sơn Việt Nhật giúp giữ nhiệt tối ưu cho đồ uống của bạn trong mọi hoàn cảnh và mọi thời điểm.

2. Chọn ca cách nhiệt sơn Việt Nhật làm quà tặng thể hiện sự tiện lợi và chăm sóc đến từng khách hàng.

1. Viet Nhat painted insulated mug helps keep your drink at optimal temperature in all circumstances and at all times.

2. Choosing Viet Nhat paint insulation mug as a gift shows convenience and care for each customer.





Vietnam Airlines

1. Khay và cốc ăn trên máy bay cho hãng máy bay Vietnam Airlines, sản phẩm tinh tế từ nhựa Tân Lập Thành luôn luôn đem đến sự đảm bảo an toàn vệ sinh và sử dụng tiện lợi nhất đến với khách hàng của hãng bay.

2. Với thiết kế nhẹ nhàng và bền bỉ, khay và cốc giúp nâng cao trải nghiệm ẩm thực trên mọi chuyến bay của khách hàng.

1. Trays and cups for Vietnam Airlines, exquisite products from Tan Lap Thanh plastic always ensure the safest and most convenient use for the airline's customers.

2. With a lightweight and durable design, the tray and cup enhance the dining experience on every customer flight.

